



For after Sales support Contact:
BDS FIRE Shepley House Restmor Way
Hackbridge Surrey SM6 7AH
Tel 020 8773 3377
E: info@bds-fire.co.uk W: www.bds-fire.co.uk



Input/Output Modules

Data Sheet



The wide range of input and output modules available from NOTIFIER delivers exceptional flexibility to a NOTIFIER fire detection and alarm system. Using these modules enables integration with a host of other building management and emergency systems, including access control systems, lifts, fire shutters and emergency lighting.

Features

- Analogue addressable communications using Opal digital protocol
- Backward compatible with legacy Notifier systems
- Built-in type identification automatically identifies these devices to the control panel
- Stable communication technique with high noise immunity
- Rotary DECADE 01 to 99 or 01 to 159 (for Opal digital protocol modules) address switches
- Common mounting options including Surface Mount, Panel Mount and DIN Rail Mount.
- Tri-colour LED's
- Powered directly by 2-wire loop. No additional power required - Option to use external power in sounder driving applications
- Plug-in terminal connections for ease of field wiring
- Approved to CEA GEI 1-082 AND CEA GEI 1-084
- CPD approval to EN54-17 and EN54-18, LPCB and VdS

Installation

There are 4 enclosures designed to accept these modules. These are details in the pages following. The single and dual input/output modules can also be mounted using either panel mount or DIN rail mount kits for maximum flexibility when interfacing with third party equipment.

This document is not intended to be used for installation purposes. Every care has been taken in the preparation of this document but no liability can be accepted for the use of the information therein. Design features may be changed or amended without prior notice.

For more information, contact:
NOTIFIER, Charles Avenue, Burgess Hill, West Sussex, RH15 9UF. United Kingdom
Phone: +44 (0) 1444 230 300 Fax: +44 (0) 1444 230 888

ISO9001
Design, Manufacture and
Supply to Quality Manage-
ment Systems Certified to
ISO9001:1994





For after Sales support Contact:
 BDS FIRE Shepley House Restmor Way
 Hackbridge Surrey SM6 7AH
 Tel 020 8773 3377
 E: info@bds-fire.co.uk W: www.bds-fire.co.uk



M710 Single input module

The M700 series modules are designed for use with any NOTIFIER protocol fire alarm control panel and include selectable loop isolation in every device.

The M710 module monitors a single input device circuit of normally open dry contact alarm activation devices.

These modules use one of 99 available module addresses on a loop and respond to regular polls from the control panel reporting its type and the status (open/normal/short) of its supervised device circuit.



Specifications

M710 Single input module

Mechanical Specification

- Dimensions:
 - Height: 90 mm
 - Width: 92 mm
 - Depth: 23 mm
- Weight: 90g
- Maximum Wire Gauge for Terminals 1.5mm²

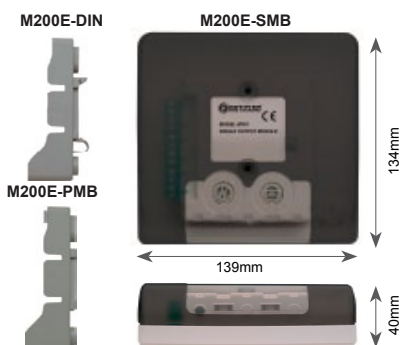

Electrical Specification

- Current Consumption
 - Without communication: 310 µA @ 24 VDC;
 - Communication every 5 sec. with LED blink enabled: 510 µA @ 24 VDC
 - Maximum Alarm Current: 5 mA @ 24 VDC (per LED with LED enabled)
- Operating Voltage: 15 to 30 VDC peak

Environmental Specifications

- Operating temperature: -20°C to +60°C
- Relative humidity: 0% to 95%, non-condensing

Connection Detail

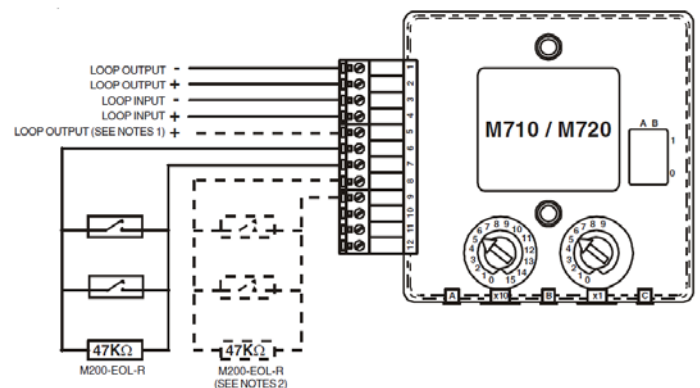

Notes:

- 1 If short circuit isolation is not required, loop output+ should be wired to terminal 5 and not 2. Terminal 5 is internally connected to terminal 4.
- 2 The dashed line circuit connected to terminals 8 and 9 should only be used with the M720. There are no connections to these terminals on the M710.
- 3 Provided the control panel is compatible, short circuit monitoring of the input circuit may be possible. An 18KΩ resistor should be wired in series with each device switch being monitored.



For after Sales support Contact:
 BDS FIRE Shepley House Restmor Way
 Hackbridge Surrey SM6 7AH
 Tel 020 8773 3377
 E: info@bds-fire.co.uk W: www.bds-fire.co.uk



Non- Addressable Zone Monitor Module M710-CZR

The M710-CZR non-addressable zone monitor module allows a zone of non-addressable detectors to communicate with a Notifier analogue addressable system. As a result existing nonaddressable loops can be integrated into a Notifier addressable system

The module monitors a zone of two-wire non-addressable smoke detectors. Each M710-CZR uses one of 99 available module addresses on a loop. The non-addressable zone can be powered from the analogue communication line or from an external power supply. Where the non-addressable zone is powered from an external power supply, the communication line is fully isolated from the nonaddressable zone and from the power supply.

This M710-CZR non-addressable Zone Monitor module fits into M200E-SMB, M200E-DIN or M200E-PMB. These may then be installed in a 19" Rack Assembly using Notifier 19" Rack mounting adapters.



Specifications

Non- Addressable Zone Monitor Module M710-CZR

Mechanical Specification

- Dimensions:

Height:	93 mm
Width:	83 mm
Depth:	23 mm
- Weight: 110 g
- Maximum Wire Gauge for Terminals 2.5mm²

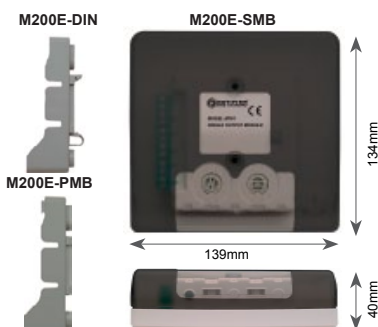
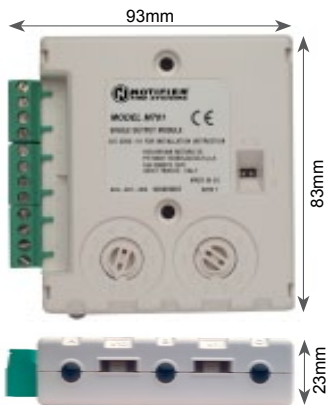

Electrical Specification

- Max Standby current 500uA @ 24V (communication every 5s with LED blink enabled, with external supply for non-addressable zone)
- Max Standby current 6.7mA @ 24V (communication every 5s with LED blink enabled, loop powered non-addressable zone, R.EOL only)
- LED Current @ 24Vdc Red:2.2uA Green: 6.6uA Yellow:8.8uA
- Max non-addressable zone current limit 60mA
- External power supply voltage 12 – 28.5V
- Maximum series resistance 50Ω
- End of Line Resistor Value: 3.9k

Environmental Specifications

- Temperature Range: -20°C to +60°C
- Humidity: 5% to 95% relative humidity (non-condensing)

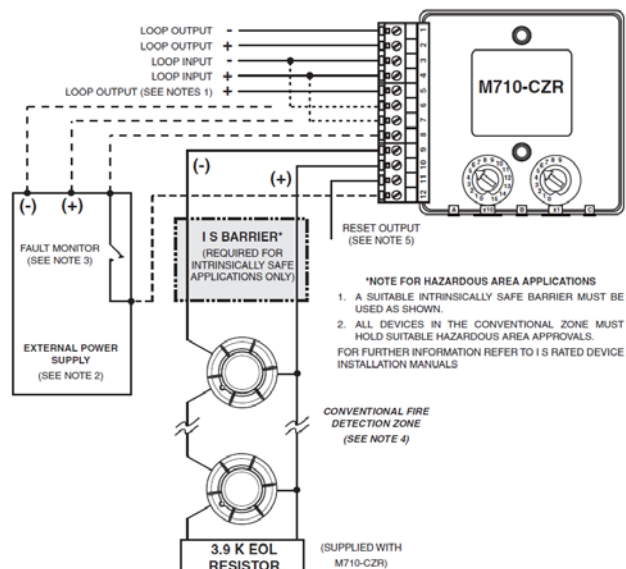



For after Sales support Contact:
 BDS FIRE Shepley House Restmor Way
 Hackbridge Surrey SM6 7AH
 Tel 020 8773 3377
 E: info@bds-fire.co.uk W: www.bds-fire.co.uk



M701 Single output module

The M700 series modules are designed for use with any NOTIFIER protocol fire alarm control panel and include selectable loop isolation in every device.

The M701 control module provides a monitored single output circuit for use with polarised loads (sounder circuit) which requires a suitable power source (7Vdc - 30Vdc) for the connected load. Alternatively the same device may be placed in to an unsupervised mode which can then be used to control any switched load up to 2A @ 30Vdc.

These modules use one of 99 available module addresses on a loop and respond to regular polls from the control panel reporting its type and the status (open/normal/short) of its supervised device circuit.



Specifications

M701 single output module

Mechanical Specification

- Dimensions:
 - Height: 90 mm
 - Width: 92 mm
 - Depth: 23 mm
- Weight: 102g

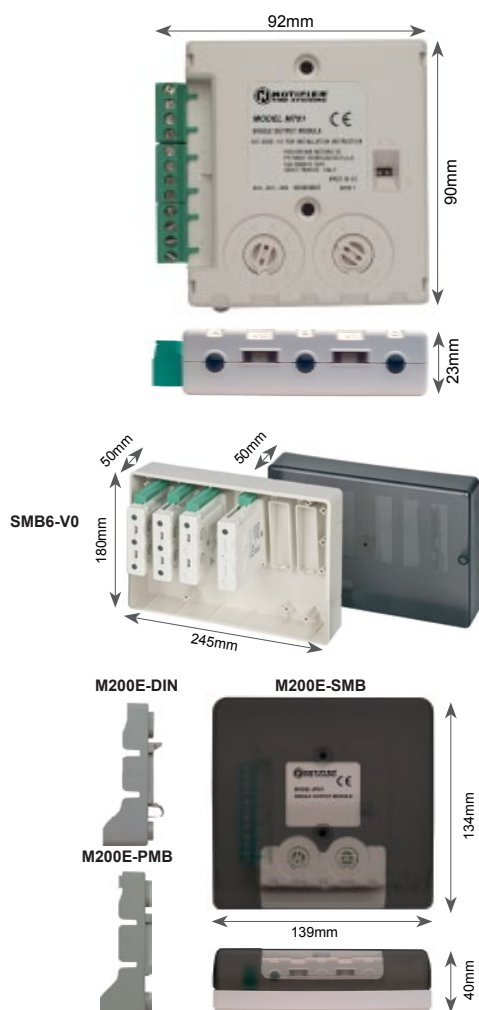

Electrical Specification

- Current Consumption (Without communication): 310 μ A @ 24 VDC
- Current Consumption (Communication every 5 sec. with LED blink enabled): 510 μ A @ 24 VDC
- Maximum Alarm Current: 5 mA @ 24 VDC (per LED with LED enabled)
- Operating Voltage: 15 to 30 VDC peak

Environmental Specifications

- Operating temperature: -20°C to +60°C
- Relative humidity: 0% to 95%, non-condensing

Connection Detail

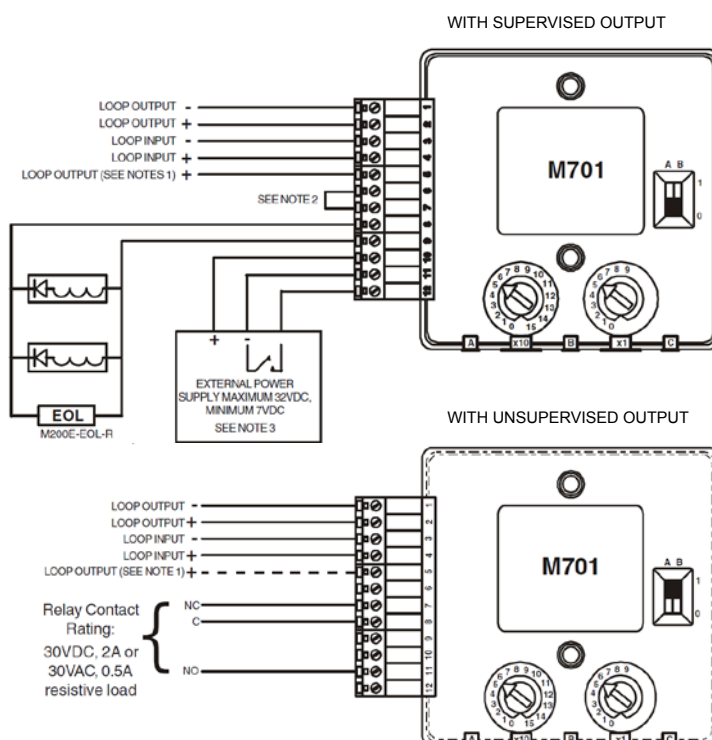



For after Sales support Contact:
 BDS FIRE Shepley House Restmor Way
 Hackbridge Surrey SM6 7AH
 Tel 020 8773 3377
 E: info@bds-fire.co.uk W: www.bds-fire.co.uk



M701-240 & M701-240-DIN Mains Switching Output Modules

The M701-240 is a loop-powered device controlling an unsupervised double pole (one normally open, one normally closed) output suitable for managing 240VAC loads. The output relay is a bistable device, latching in the on or off state on command from the control panel. The module is supplied in a wall mounting box as standard with a grounding terminal provided.

The M701-240-DIN has the same features and capabilities as the M701-240 but is designed to mount directly on to a standard 35mm 'Top Hat' DIN rail. The module is supplied unboxed for installation in a suitable enclosure.

Each module has built-in short circuit protection for the communications loop; however, to increase application flexibility, the isolators can be selected/deselected on an individual module basis.



Specifications

M701-240 & M701-240-DIN Mains Switching Output Modules

Mechanical Specification M701-240

- Dimensions:
 - Height: 40 mm
 - Width: 134 mm
 - Depth: 139 mm
- Weight 195g
- Maximum Wire Gauge for Terminals 1.5mm²

Mechanical Specification M701-240-DIN

- Dimensions:
 - Height: 48 mm
 - Width: 125 mm
 - Depth: 76 mm
- Weight 140g
- Maximum Wire Gauge for Terminals 2.5mm²

Electrical Specification

- Current Consumption (Without communication) 275 µA @ 24 VDC
- Current Consumption (Communication every 5 sec. with LED blink enabled) 445 µA @ 24 VDC
- Maximum Alarm Current: 5 mA @ 24 VDC (per LED with LED enabled)
- Operating Voltage: 15 to 30 VDC peak
- Relay Specifications 5A at 30VDC, 5A at 250VAC, resistive load 1 x NO and 1 x NC contacts

Environmental Specifications

- Operating temperature -20°C to +60°C
- Relative humidity: 0% to 95%, non-condensing

Connection Detail

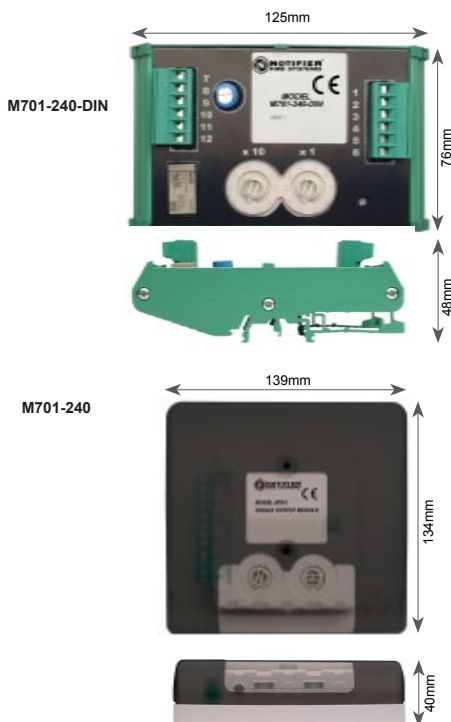
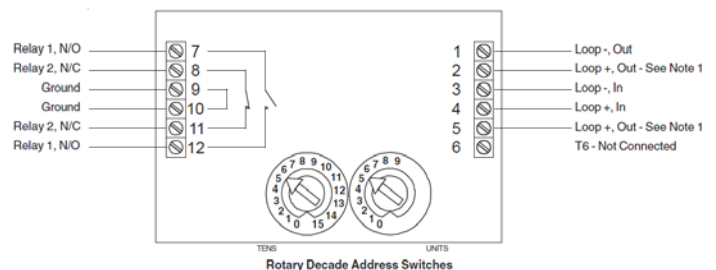



For after Sales support Contact:
 BDS FIRE Shepley House Restmor Way
 Hackbridge Surrey SM6 7AH
 Tel 020 8773 3377
 E: info@bds-fire.co.uk W: www.bds-fire.co.uk



M720 Dual Input Module

The M700 series modules are designed for use with any NOTIFIER protocol fire alarm control panel and include selectable loop isolation in every device.

The M720 dual monitor module provides two supervised input device circuits of normally open dry contact alarm activation devices.

The M720 module uses two addresses of 99 available module addresses on a loop and responds to regular polls from the control panel reporting its type and the status (open/normal/short) of their supervised device circuits.



Specifications

M720 Dual Input Module

Mechanical Specification

- Dimensions:

Height:	90 mm
Width:	92 mm
Depth:	23 mm
- Weight: 90g

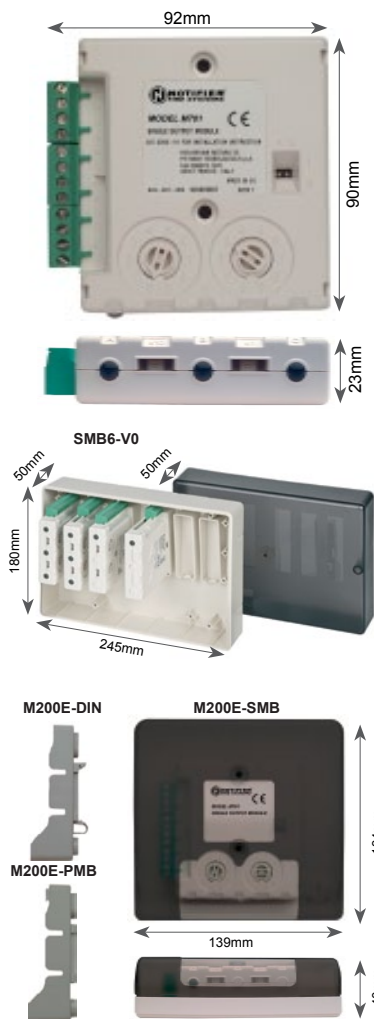

Electrical Specification

- Current Consumption

Without communication	340 μ A @ 24 VDC;
Communication every 5 sec. with LED blink enabled.	600 μ A @ 24 VDC
- Maximum Alarm Current: 5 mA @ 24 VDC (per LED with LED enabled)
- Operating Voltage: 15 to 30 VDC peak

Environmental Specifications

- Operating temperature: -20°C to +60°C
- Relative humidity: 0% to 95%, non-condensing

Connection Detail

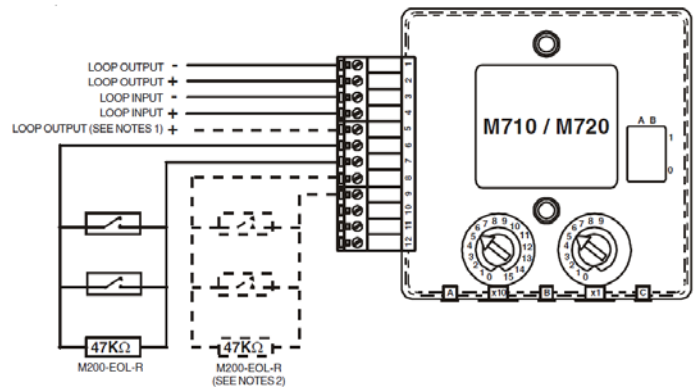

Notes:

- If short circuit isolation is not required, loop output+ should be wired to terminal 5 and not 2. Terminal 5 is internally connected to terminal 4.
- The dashed line circuit connected to terminals 8 and 9 should only be used with the M720. There are no connections to these terminals on the M710.
- Provided the control panel is compatible, short circuit monitoring of the input circuit may be possible. An 18K Ω resistor should be wired in series with each device switch being monitored.



For after Sales support Contact:
 BDS FIRE Shepley House Restmor Way
 Hackbridge Surrey SM6 7AH
 Tel 020 8773 3377
 E: info@bds-fire.co.uk W: www.bds-fire.co.uk



M721 Dual Input Module with Output

The M700 series modules are designed for use with any NOTIFIER protocol fire alarm control panel and include selectable loop isolation in every device.

The M721 dual input, single relay output module, as well as providing two supervised inputs also provides a single change over relay output rated at 2A @30Vdc.

The M721 uses three addresses of 99 available module addresses on a loop and responds to regular polls from the control panel reporting its type and the status (open/normal/short) of their supervised device circuits.



Specifications

M721 Dual Input Module with Output

Mechanical Specification

- Dimensions:
 - Height: 90 mm
 - Width: 92 mm
 - Depth: 23 mm
- Weight: 102g

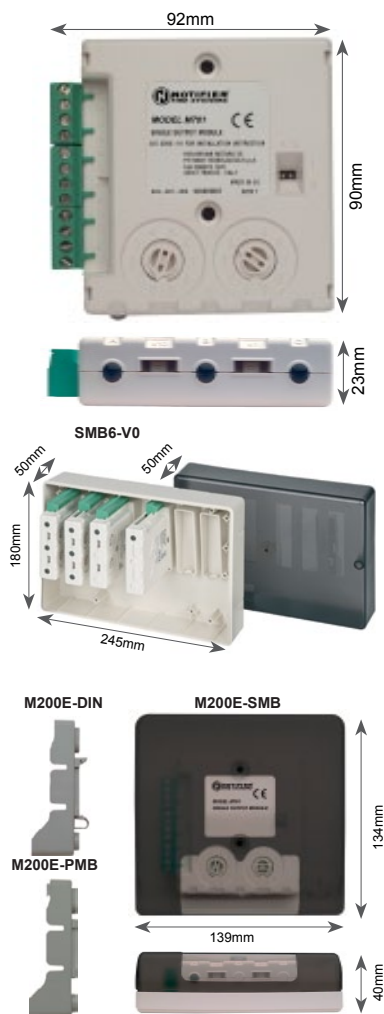

Electrical Specification

- Current Consumption
 - Without communication: 340 μ A @ 24 VDC;
 - Communication every 5 sec. with LED blink enabled: 660 μ A @ 24 VDC
 - Maximum Alarm Current: 5 mA @ 24 VDC (per LED with LED enabled)
- Operating Voltage: 15 to 30 VDC peak

Environmental Specifications

- Operating temperature: -20°C to +60°C
- Relative humidity: 0% to 95%, non-condensing

Connection Detail

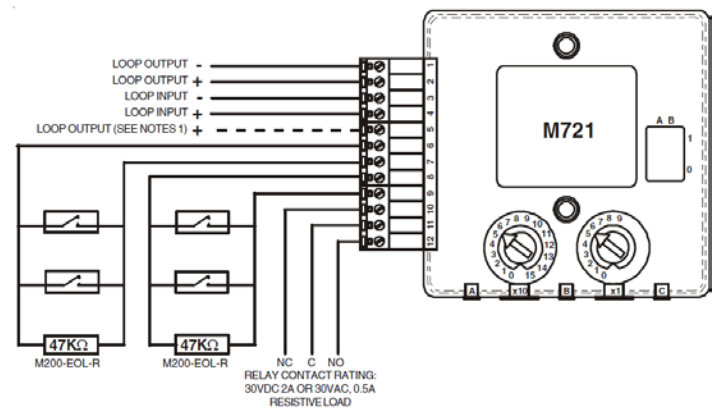

Notes:

- If short circuit isolation is not required, loop output+ should be wired to terminal 5 and not 2. Terminal 5 is internally connected to terminal 4.
- Provided the control panel is compatible, short circuit fault monitoring of the input circuit may be possible. An 18K Ω resistor should be wired in series with each device switch being monitored.



For after Sales support Contact:
 BDS FIRE Shepley House Restmor Way
 Hackbridge Surrey SM6 7AH
 Tel 020 8773 3377
 E: info@bds-fire.co.uk W: www.bds-fire.co.uk



NFX-MM1M Mini Module

The NFX-MM1M is an addressable input module. It will interface with contact devices such as security contacts, sprinkler flow switches and call points. It monitors the cable in the same way as a non-addressable zone, using an end of line resistor on a two wire circuit.

In addition to transmitting the supervised state of the monitored device (normal, open, or short), the full analogue supervision measurement is sent back to the panel.

The compact size allows it to fit inside devices or junction boxes behind devices. Its size and light weight allows it to be installed without the need to be rigidly mounted.



Specifications

NFX-MM1M Mini Module

Mechanical Specification

- Dimensions:
 - Height: 33 mm
 - Width: 71 mm
 - Depth: 15 mm
- Weight: 57 g

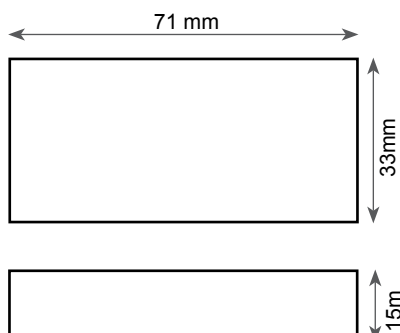
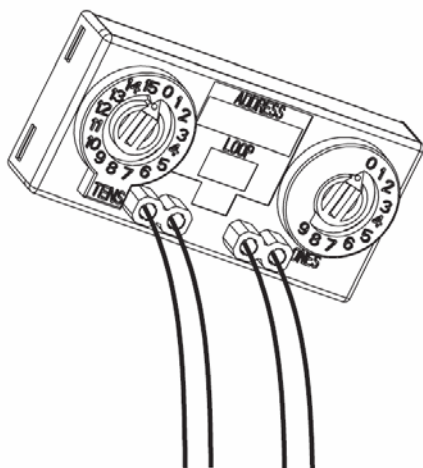

Electrical Specification

Communications Loop

- Nominal Operating Voltage: 15-32 VDC
- Average Operating Current: 400 μ A, 1 comm. every 5 seconds, 47K EOL
- Nominal Standby Current: 110 μ A
- Maximum Alarm Current: 600 μ A

Monitoring Line

- EOL Resistance: 47K Ohms
- Maximum Wiring Resistance: 1.5K Ohms
- Maximum Voltage to EOL: 11 Volts
- Maximum Short Circuit Current: 217 μ A

Environmental Specifications

- Operating temperature: 0°C to +49°C
- Relative humidity: 10% to 93%, non-condensing

Connection Detail

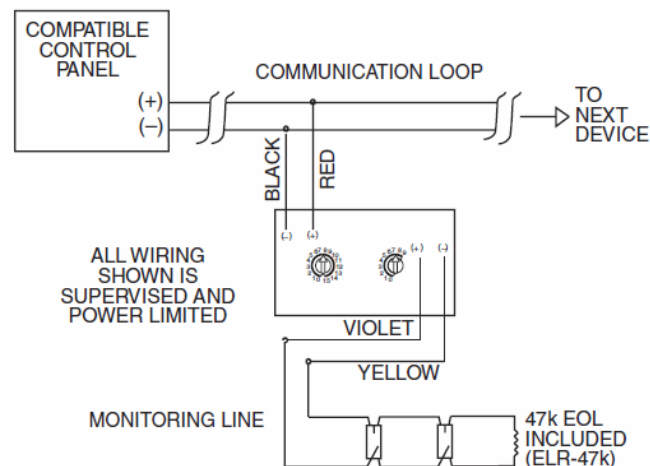



For after Sales support Contact:
 BDS FIRE Shepley House Restmor Way
 Hackbridge Surrey SM6 7AH
 Tel 020 8773 3377
 E: info@bds-fire.co.uk W: www.bds-fire.co.uk



Six Channel Output Module NFXI-RM6

The six channel output module is designed for use in applications where numerous single modules are required. The monitor and control module can be used to supervise and activate sounders, strobes, door closers, break glass call points, waterflow switches and other ancillary devices.

The NFXI-RM6 consists of six changeover relays. A single isolated set of dry relay contacts, which can be wired as normally open or normally closed, is provided for each address. The module enables the control panel to switch contacts on demand. The controlled circuit is not supervised.

In Opal Digital Protocol only one address is used for the entire multimodule with sub-addresses completing the remaining addresses. For compatibility with existing installations using Notifier CLIP Protocol, the first address is set from 01 to 94; the other modules are automatically assigned the next five addresses; up to four unused addresses can be disabled by dip switch.



Specifications

Six Channel Output Module NFXI-RM6

Mechanical Specification

- Dimensions:

Height:	25 mm
Width:	173 mm
Depth:	147 mm
- Weight 0.5 kg (package included)
- Wire Gauge for Terminals

Maximum	3.25 mm ² (12 AWG)
Minimum	0.8 mm ² (18 AWG)

Features

- Uses Opal protocol (up to 159 addresses)
- Individual Tri-colors LED indicators
- Controllable Isolation
- Unused addresses may be disabled
- Rotary address switches
- Class B operation
- Removable plug-in terminal blocks
- Complies with EN54-17 and EN54-18

Mounting Detail

The multiple input and output modules are PCB Boards and need to be mounted in suitable metal enclosures.

M200-SMB-MM Surface mounting metal box.

Dimensions H 280 x W 229 x D 64mm

Electrical Specification

- Maximum Standby Current 1450 uA
- Maximum Alarm Current (red LED) 5 mA
- Relay current (max) 50mA
- Relay Contact Ratings 3A @ 30 VDC, 0.25A @ 250 VAC at 23 °C
- Operating Voltage Range 15-32 VDC
- Maximum Wiring Resistance 40 ohm

Environmental Specifications

- Operating Temperature -10°C to +55°C
- Operating Humidity Range: 10% to 93% RH

Connection Detail

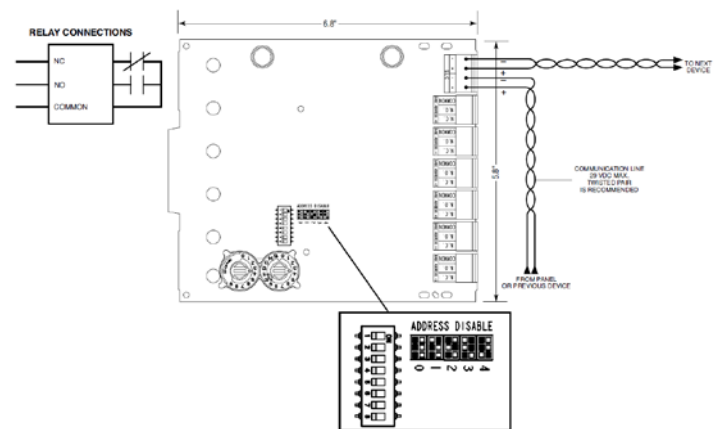



For after Sales support Contact:
 BDS FIRE Shepley House Restmor Way
 Hackbridge Surrey SM6 7AH
 Tel 020 8773 3377
 E: info@bds-fire.co.uk W: www.bds-fire.co.uk



Ten Channel Input Module NFXI-MM10

The NFXI-MM10 provides an interface with normally open contact devices. The supervised state: normal, open circuit fault or short circuit alarm is sent back to the control panel.

In Opal Digital Protocol only one address is used for the entire multimodule with sub-addresses completing the remaining addresses. For compatibility with existing installations using Notifier CLIP Protocol, the first address is set from 01 to 90; the other modules are automatically assigned the next nine addresses; up to six unused addresses can be disabled by dip switch.



Specifications

Ten Channel Input Module NFXI-MM10

Mechanical Specification

- Dimensions:

Height:	25 mm
Width:	173 mm
Depth:	147 mm
- Weight: 0.5 kg (package included)
- Wire Gauge for Terminals

Maximum	3.25 mm ² (12 AWG)
Minimum	0.8 mm ² (18 AWG)

Features

- Uses Opal protocol (up to 159 addresses)
- Individual Tri-colors LED indicators
- Controllable Isolation
- Unused addresses may be disabled
- Rotary address switches
- Class B operation
- Removable plug-in terminal blocks
- Complies with EN54-17 and EN54-18

Mounting Detail

The multiple input and output modules are PCB Boards and need to be mounted in suitable metal enclosures.

M200-SMB-MM Surface mounting metal box.

Dimensions H 280 x W 229 x D 64mm

Electrical Specification

- Maximum Standby Current: 3500 uA
- Maximum Alarm Current (red LED): 5 mA
- Maximum Supervising Line Wiring Resistance: 40 ohm
- Operating Voltage Range: 15-32 VDC
- Maximum Wiring Resistance: 40 ohm

Environmental Specifications

- Operating Temperature: -10°C to +55°C
- Operating Humidity Range: 10% to 93% RH

Connection Detail

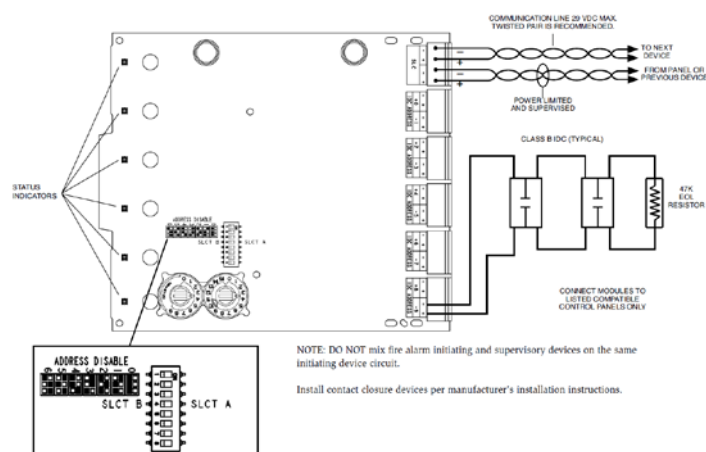



For after Sales support Contact:
 BDS FIRE Shepley House Restmor Way
 Hackbridge Surrey SM6 7AH
 Tel 020 8773 3377
 E: info@bds-fire.co.uk W: www.bds-fire.co.uk



10 Way Output Module CMX-10RM

Each output is individually addressed and controlled by the control equipment. This provides a cost effective, compact solution for installations requiring multiple switching and / or monitoring at a single location.

Each output consists of a form C (change over) relay contact providing both normally open and normally closed contacts rated 2A at 30Vdc.

Each module card utilises up to 10 consecutive addresses with the base address being set by DIP switch although any of the 10 addresses may be individually disabled allowing the use of this address by other modules on that loop.

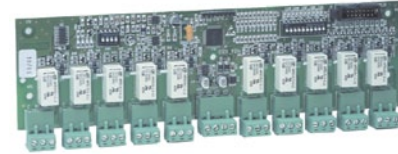

Specifications

10 Way Output Module CMX-10RM

Mechanical Specification

- Dimensions:

Height:	233 mm
Width:	70 mm
Depth:	13 mm

The modules are supplied as a P.C.B. allowing installation in to other equipment housings such as control cabinets. 5 x 3.5mm mounting holes provide suitable secure mounting for the P.C.B's. Each module occupies a single Notifier Loop Module address with the first address being set by DIP switch SW2 and subsequent address being base address + n up to a maximum of 10. Individual modules may be disabled via a second DIP switch SW1 such that any module address in the range can be used for other module addresses on the loop.

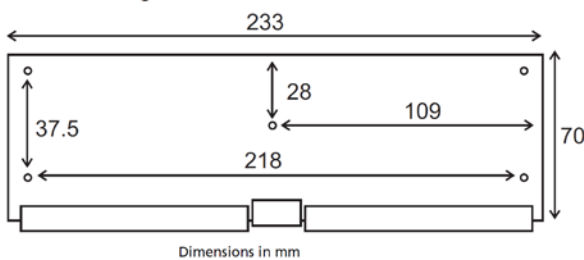

Mounting Detail

Mount using multi-mount enclosure 002-439



Electrical Specification

- Current Consumption
1.7mA with communication and LED blink enabled
- LED Current, 5mA @ 24Vdc (LED on) per module

Environmental Specifications

- Operating temperature -10°C to +55°C
- Relative humidity: 10% to 93%, non-condensing

Connection Detail

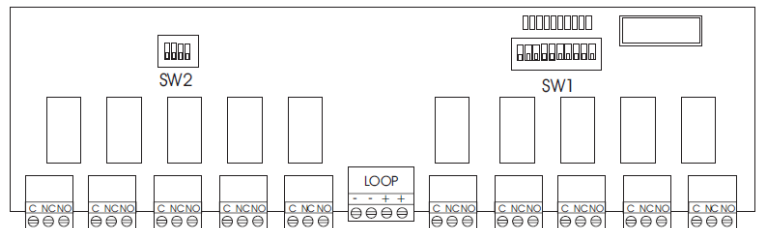



For after Sales support Contact:
 BDS FIRE Shepley House Restmor Way
 Hackbridge Surrey SM6 7AH
 Tel 020 8773 3377
 E: info@bds-fire.co.uk W: www.bds-fire.co.uk



10 Way Input Module MMX-10M

Each input is individually addressed and controlled by the control equipment. This provides a cost effective, compact solution for installations requiring multiple switching and / or monitoring at a single location.

Inputs may be configured to monitor for open circuit, short circuit and active (fire) conditions.

Each module card utilises up to 10 consecutive addresses with the base address being set by DIP switch although any of the 10 addresses may be individually disabled allowing the use of this address by other modules on that loop.



Specifications

10 Way Input Module MMX-10M

Mechanical Specification

- Dimensions:

Height:	233 mm
Width:	70 mm
Depth:	13 mm

The modules are supplied as a P.C.B. allowing installation in to other equipment housings such as control cabinets. 5 x 3.5mm mounting holes provide suitable secure mounting for the P.C.B's. Each module occupies a single Notifier Loop Module address with the first address being set by DIP switch SW2 and subsequent address being base address + n up to a maximum of 10. Individual modules may be disabled via a second DIP switch SW1 such that any module address in the range can be used for other module addresses on the loop.

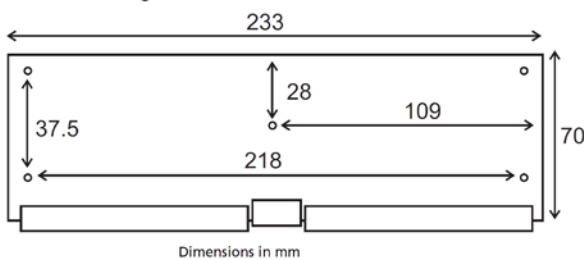

Electrical Specification

- Current Consumption
1.7mA with communication and LED blink enabled
- LED Current, 5mA @ 24Vdc (LED on) per module

Environmental Specifications

- Operating temperature -10°C to +55°C
- Relative humidity: 10% to 93%, non-condensing

Connection Detail

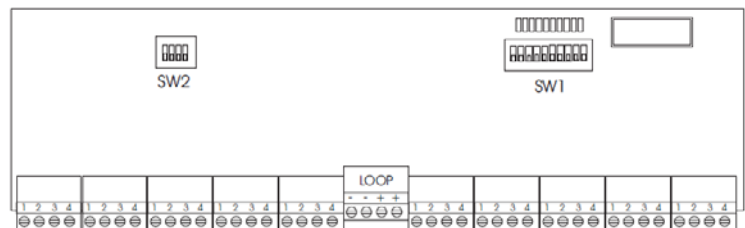

Mounting Detail

Mount using multi-mount enclosure 002-439





5 Way Input and 5 Way Output Module MCX-55

Each input and output are individually addressed and controlled by the control equipment and provide a cost effective, compact solution for installations requiring multiple switching and / or monitoring at a single location.

Inputs may be configured to monitor for open circuit, short circuit and active (fire) conditions. Each output consists of a form C (change over) relay contact providing both normally open and normally closed contacts rated 2A at 30Vdc.

Each module card utilises up to 10 consecutive addresses with the base address being set by DIP switch although any of the 10 addresses may be individually disabled allowing the use of this address by other modules on that loop.



Specifications

MCX-55 5 Way Input and 5 Way Output Module

Mechanical Specification

- Dimensions:

Height:	233 mm
Width:	70 mm
Depth:	13 mm

The modules are supplied as a P.C.B. allowing installation in to other equipment housings such as control cabinets. 5 x 3.5mm mounting holes provide suitable secure mounting for the P.C.B's as indicated overleaf. Each module occupies a single Notifier Loop Module address with the first address being set by DIP switch SW2 and subsequent address being base address + n up to a maximum of 10. Individual modules may be disabled via a second DIP switch SW1 such that any module address in the range can be used for other module addresses on the loop.

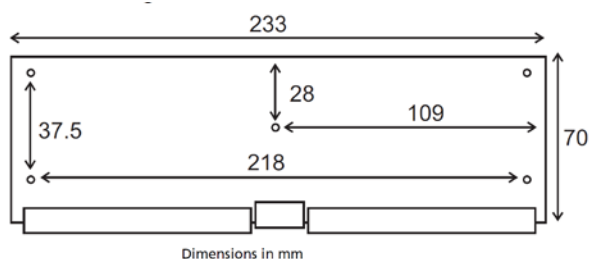

Mounting Detail

Mount using multi-mount enclosure 002-439



Electrical Specification

- Current Consumption
1.7mA with communication and LED blink enabled
- LED Current, 5mA @ 24Vdc (LED on) per module







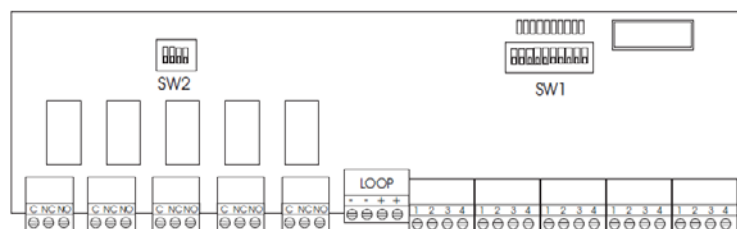









Environmental Specifications

- Operating temperature -10°C to +55°C
- Relative humidity: 10% to 93%, non-condensing

Connection Detail



Product Range at a Glance

		Part Number
	Single output module	M701
	Single input unit	M710
	Dual input unit	M720
	Dual input, single output module	M721
	Single 230Vac output unit inc. surface mount box	M701-240
	Single 230Vac output unit inc. DIN rail mounting enclosure	M701-240-DIN
	Surface Mount Box	M200E-SMB
	Surface Mount Box for 6 M7xx series modules	SMB6-V0
	Panel Mount Bracket	M200E-PMB
	DIN rail mounting clip	M200E-DIN
	Addressable micro monitor (input) module - Opal compatible without isolator	NFX-MM1M
	Six Channel Output Module - Opal protocol changeover relay output with built-in loop isolation. Complete with rotary address switch and plug-in terminal blocks. Requires M200-SMB-MM for mounting	NFXI-RM6
	Ten Channel Input Module - Opal protocol input module with built-in loop isolation. Complete with rotary address switch and plug-in terminal blocks. Requires M200-SMB-MM for mounting	NFXI-MM10
	Surface mounting metal box. H 280 x W 229 x D 64mm Suitable for mouning one module. (NFXI-RM6, NFXI-MM10)	M200-SMB-MM
	10 Way Relay Output Module	CMX-10RM
	10 Way Input Module	MMX-10M
	5 Way Input & 5 Way Relay Output Module	MCX-55
	Multi-Mount Enclosure. Metal, NOTIFIER Black/Grey. The enclosure is capable of housing: one CMX-10RM or MMX- 10M or MCX-55 module, or up to two MRM or ZMX modules or one NION-232B.	002-439



For after Sales support Contact:
 BDS FIRE Shepley House Restmor Way
 Hackbridge Surrey SM6 7AH
 Tel 020 8773 3377
 E: info@bds-fire.co.uk W: www.bds-fire.co.uk



Charles Avenue | T: +44 (0) 116 246 2255
 Burgess Hill | F: +44 (0) 116 246 2210
 W. Sussex | E: sales@notifierfiresystems.co.uk
 RH15 9UF | www.notifierfiresystems.co.uk